

JAPANESE WWII CARTRIDGE CASES

This is very much a work in progress as more information comes to light. If you have any information to add please let us know.

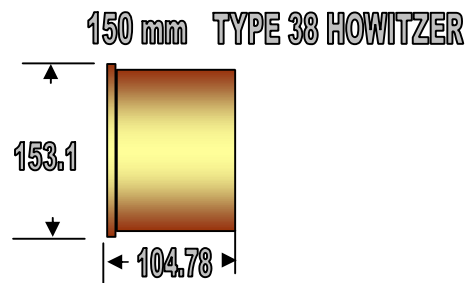

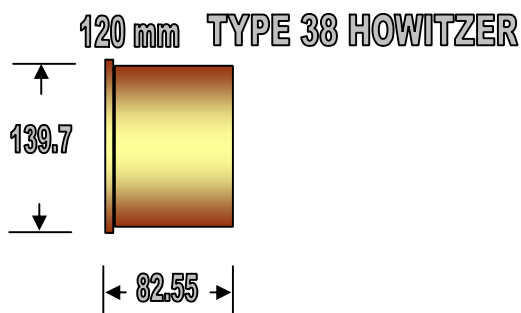
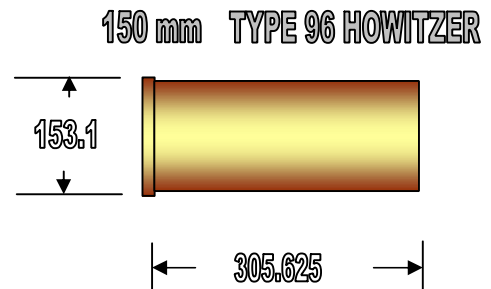
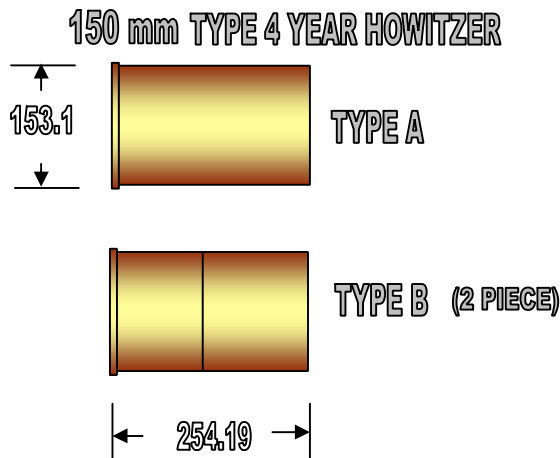
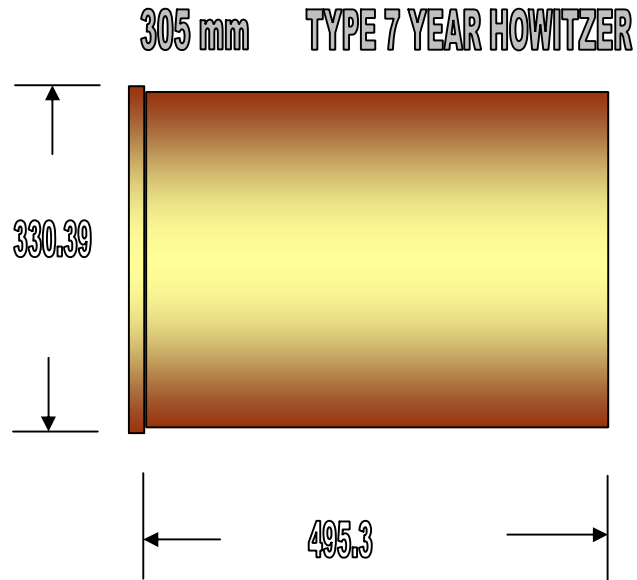
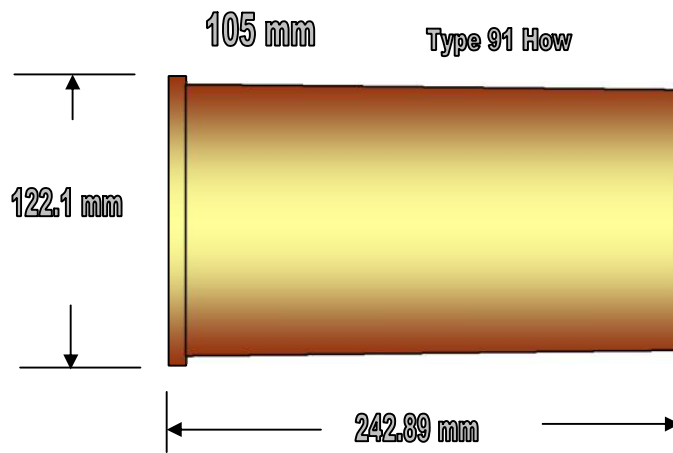
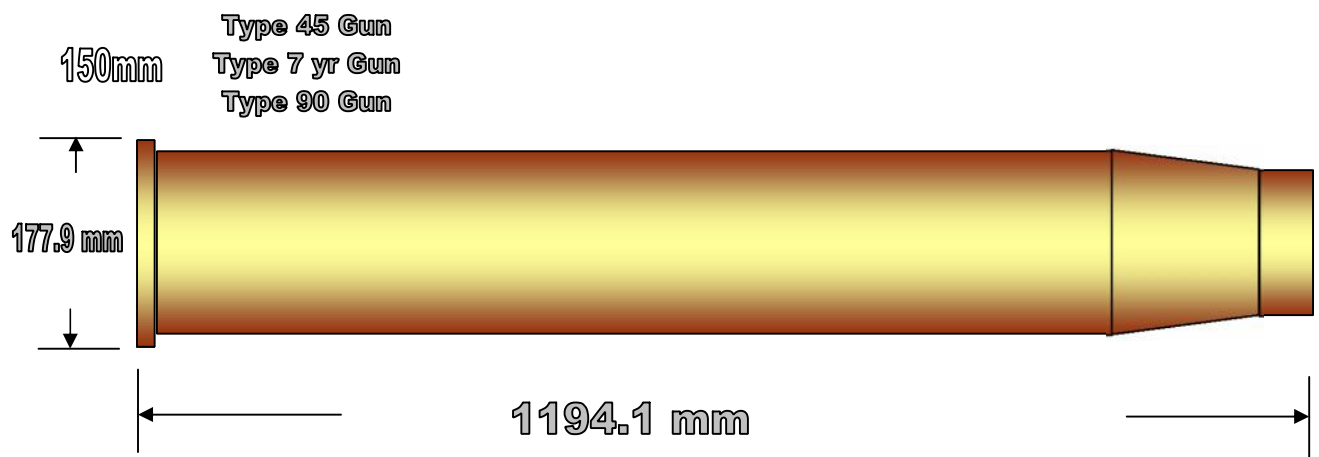

Steel version

105 mm Type 38 Gun

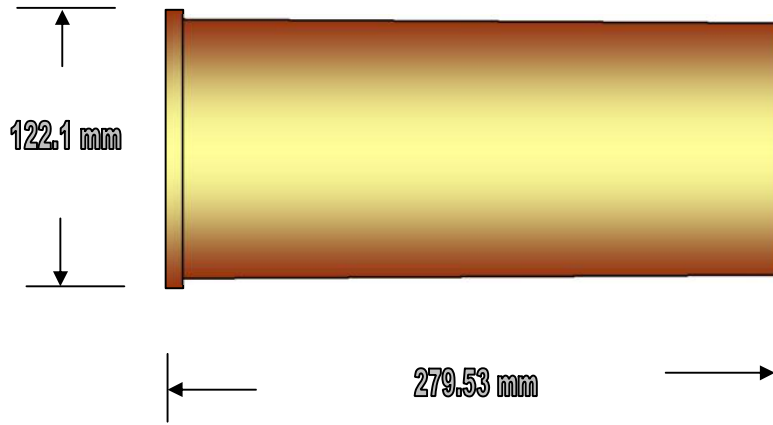

150mm Type 14 yr Gun

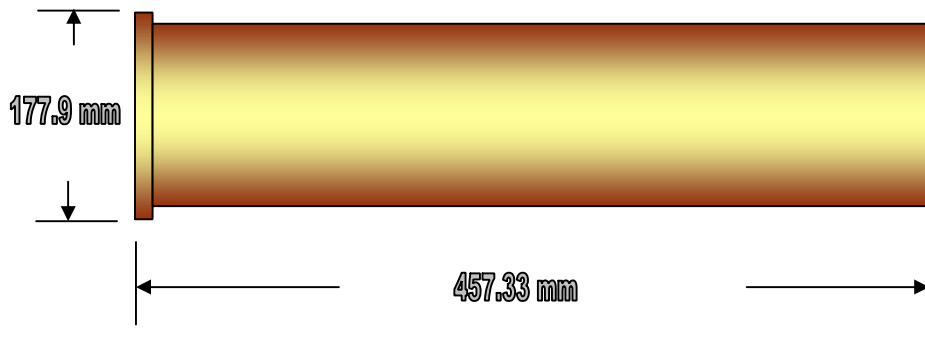

150mm Type 14 yr AA Gun

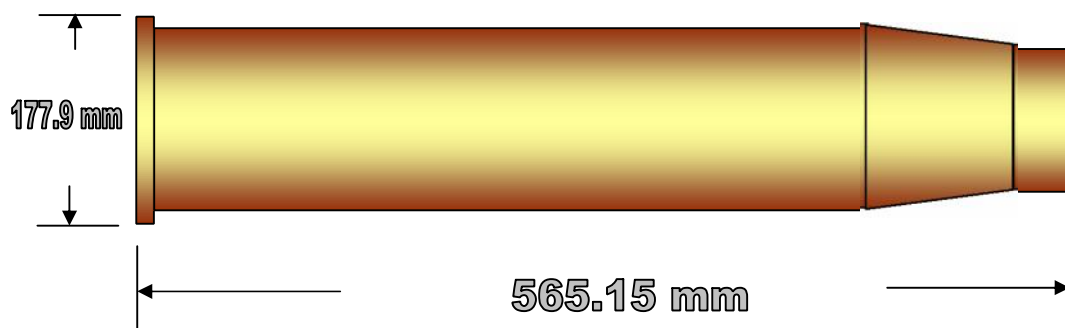

150mm Type 92 Gun

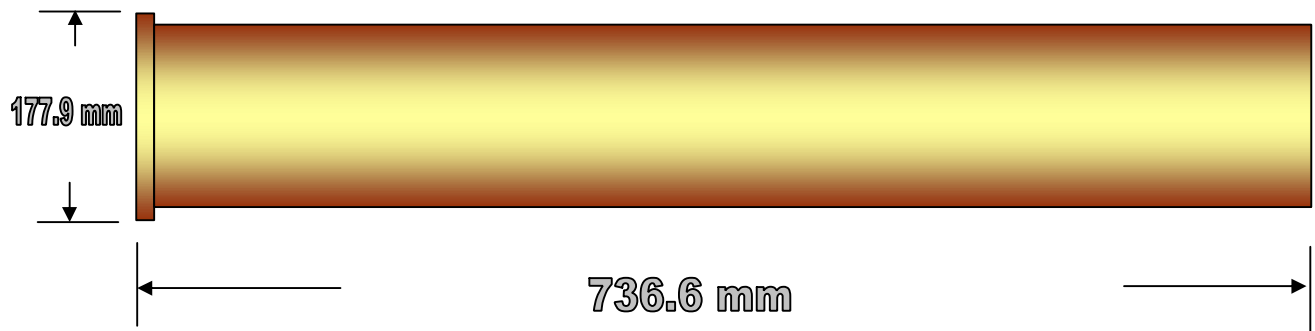

200 mm Semi-fixed

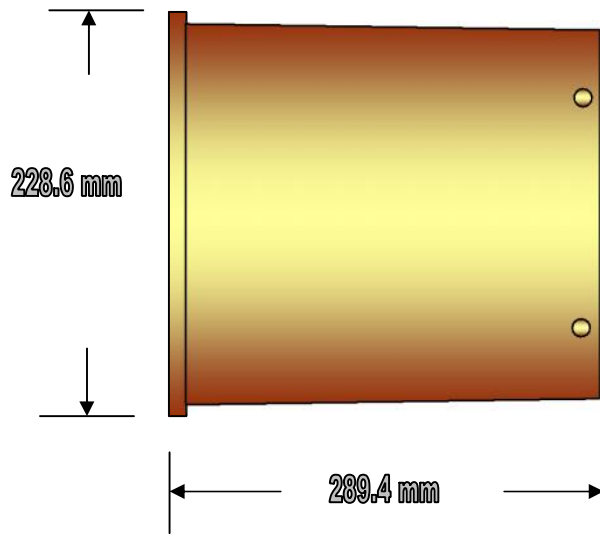

Unidentified 140 mm

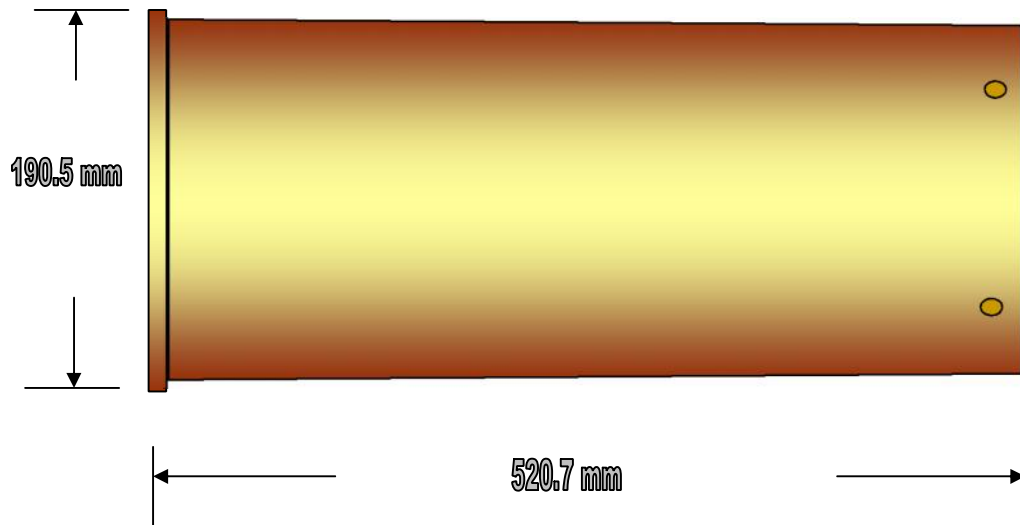

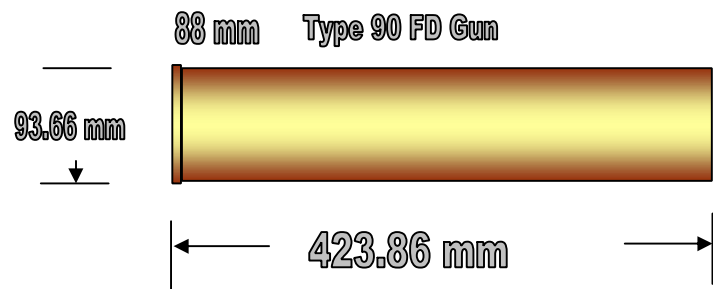
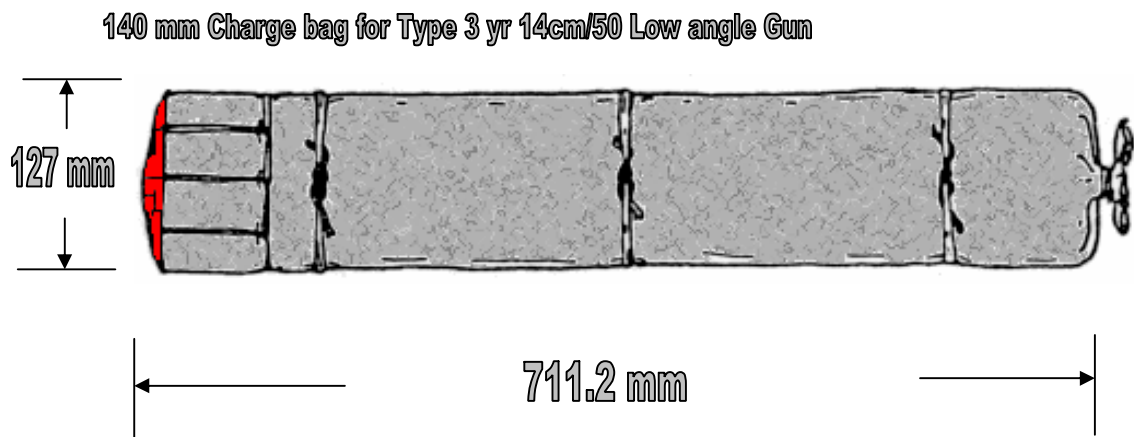
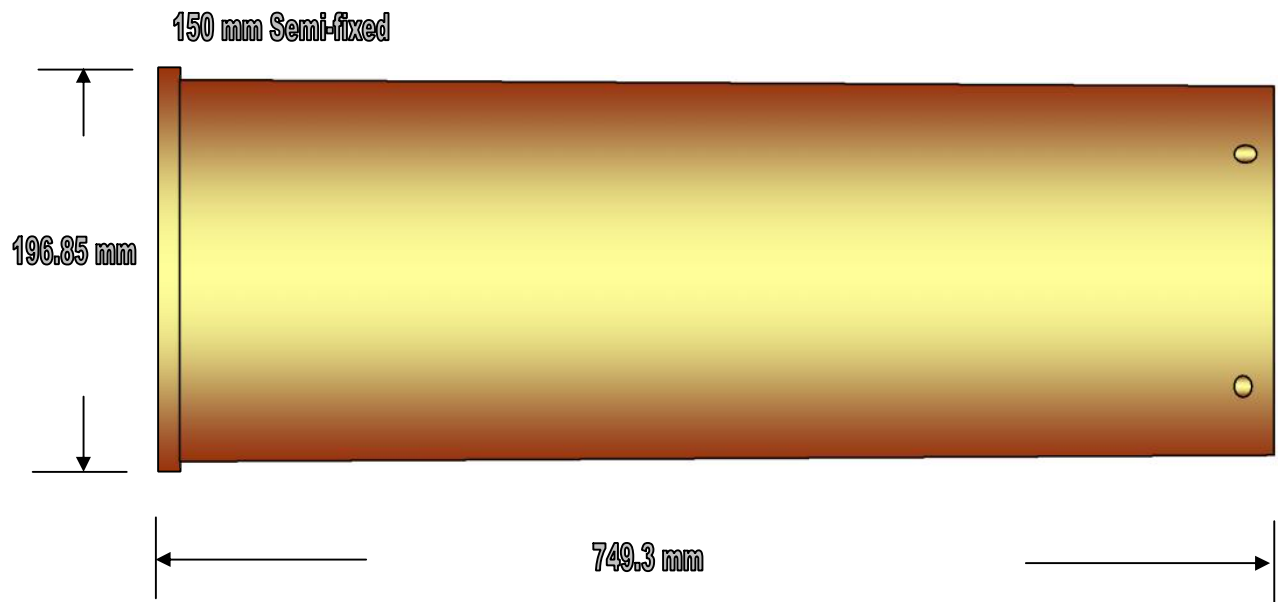

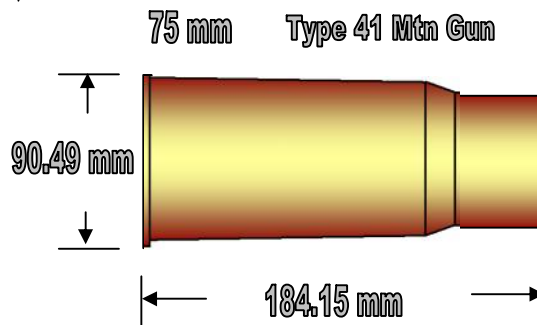
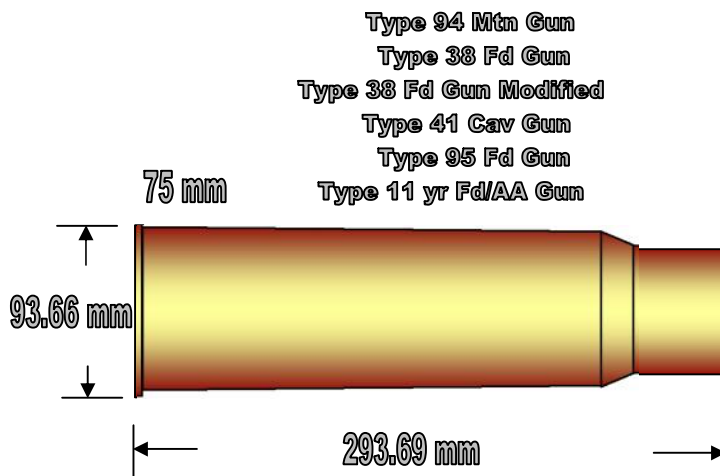
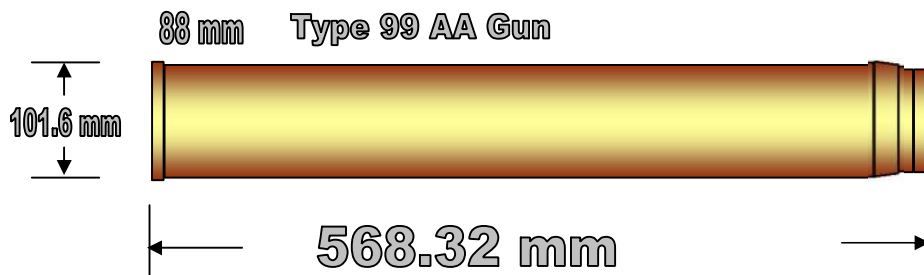
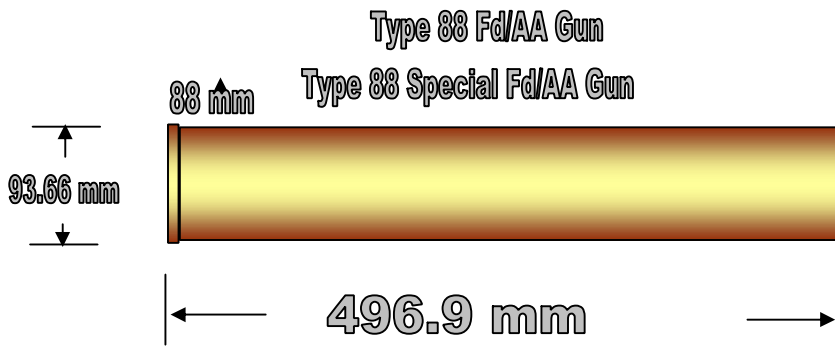

70 mm

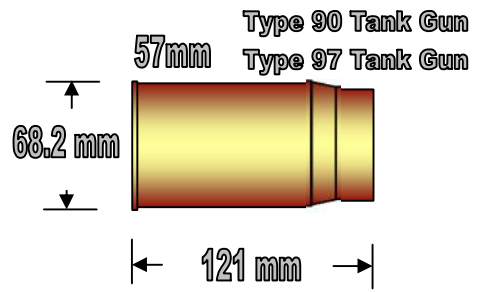
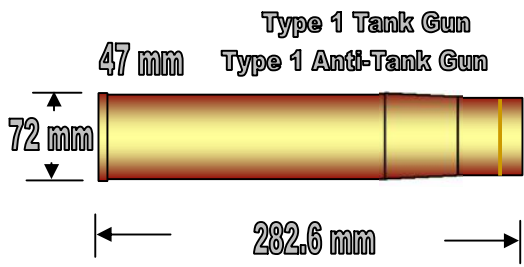
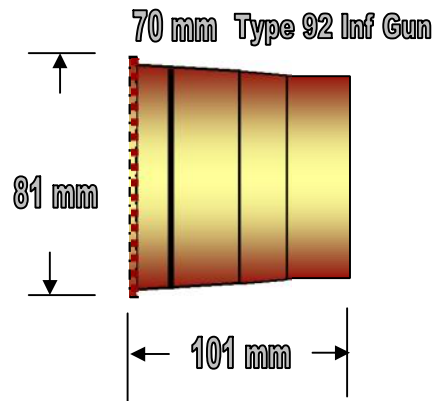
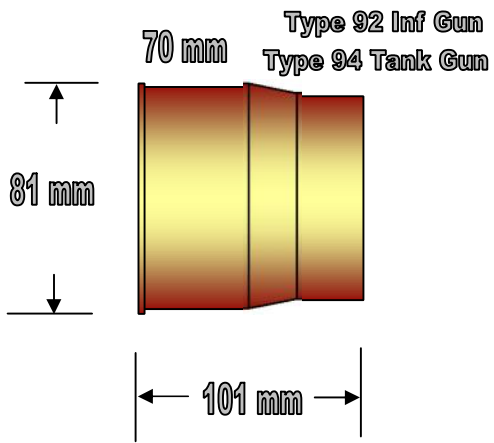

8 cm Semi-fixed

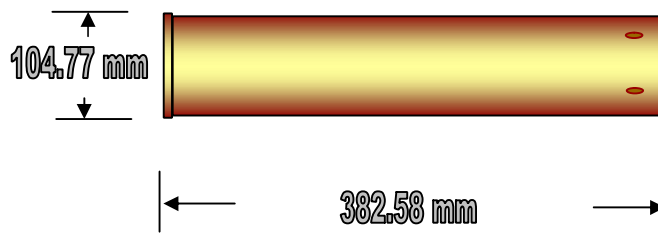

8 cm Fixed

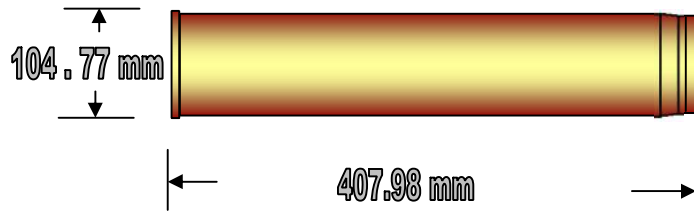

This cartridge was originally an English design adopted by the Japanese Navy. It will be found in both British and Japanese manufacture.

10 cm Fixed HA AA

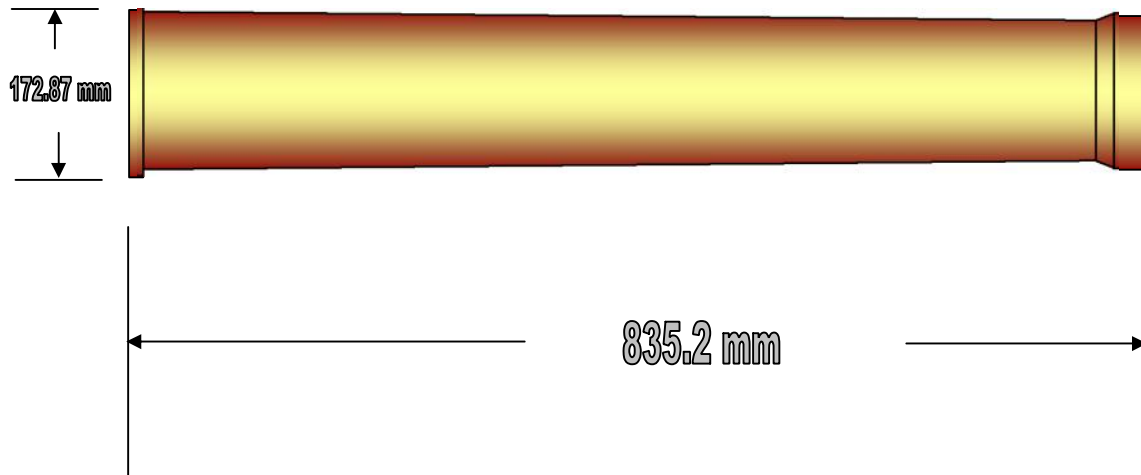

12 cm Short Fixed

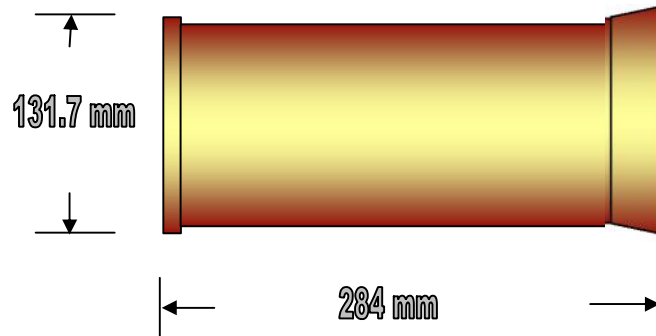

12 Cm Semi-fixed (British Armstrong)

Type 3 year Gun (Low Angle)

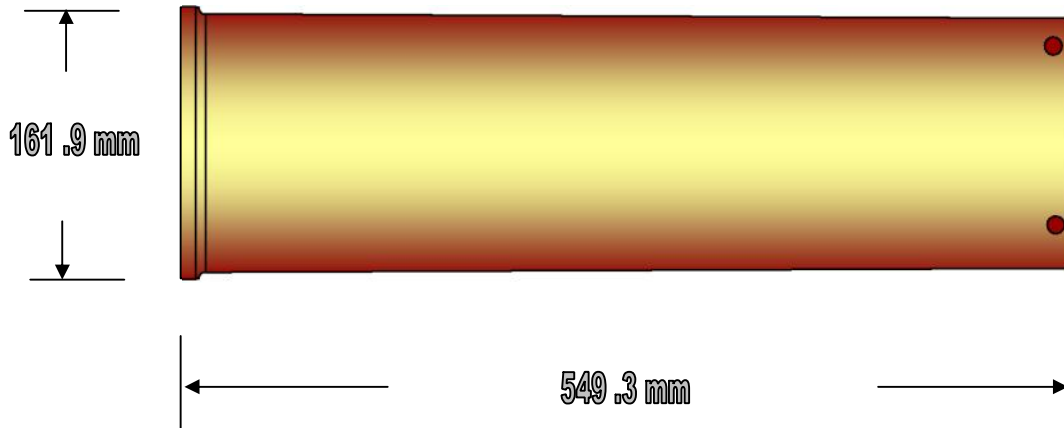

12 Cm Fixed AA

Type 10 Year HA

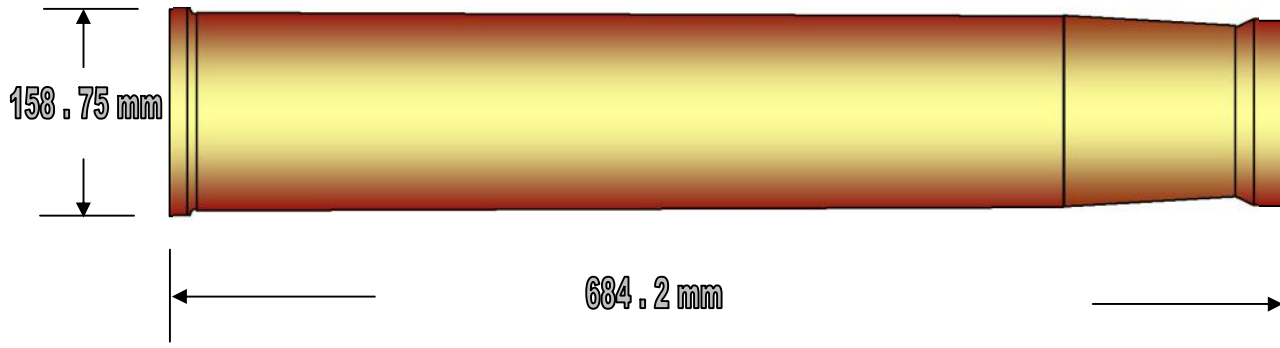

12.7 Cm Fixed AA

Type 89 HA

